

# ON Semiconductor

## Is Now

# onsemi™

To learn more about onsemi™, please visit our website at  
[www.onsemi.com](http://www.onsemi.com)

---

**onsemi** and **onsemi** and other names, marks, and brands are registered and/or common law trademarks of Semiconductor Components Industries, LLC dba "**onsemi**" or its affiliates and/or subsidiaries in the United States and/or other countries. **onsemi** owns the rights to a number of patents, trademarks, copyrights, trade secrets, and other intellectual property. A listing of **onsemi** product/patent coverage may be accessed at [www.onsemi.com/site/pdf/Patent-Marking.pdf](http://www.onsemi.com/site/pdf/Patent-Marking.pdf). **onsemi** reserves the right to make changes at any time to any products or information herein, without notice. The information herein is provided "as-is" and **onsemi** makes no warranty, representation or guarantee regarding the accuracy of the information, product features, availability, functionality, or suitability of its products for any particular purpose, nor does **onsemi** assume any liability arising out of the application or use of any product or circuit, and specifically disclaims any and all liability, including without limitation special, consequential or incidental damages. Buyer is responsible for its products and applications using **onsemi** products, including compliance with all laws, regulations and safety requirements or standards, regardless of any support or applications information provided by **onsemi**. "Typical" parameters which may be provided in **onsemi** data sheets and/or specifications can and do vary in different applications and actual performance may vary over time. All operating parameters, including "Typicals" must be validated for each customer application by customer's technical experts. **onsemi** does not convey any license under any of its intellectual property rights nor the rights of others. **onsemi** products are not designed, intended, or authorized for use as a critical component in life support systems or any FDA Class 3 medical devices or medical devices with a same or similar classification in a foreign jurisdiction or any devices intended for implantation in the human body. Should Buyer purchase or use **onsemi** products for any such unintended or unauthorized application, Buyer shall indemnify and hold **onsemi** and its officers, employees, subsidiaries, affiliates, and distributors harmless against all claims, costs, damages, and expenses, and reasonable attorney fees arising out of, directly or indirectly, any claim of personal injury or death associated with such unintended or unauthorized use, even if such claim alleges that **onsemi** was negligent regarding the design or manufacture of the part. **onsemi** is an Equal Opportunity/Affirmative Action Employer. This literature is subject to all applicable copyright laws and is not for resale in any manner. Other names and brands may be claimed as the property of others.



Is Now Part of



**ON Semiconductor®**

To learn more about ON Semiconductor, please visit our website at  
[www.onsemi.com](http://www.onsemi.com)

Please note: As part of the Fairchild Semiconductor integration, some of the Fairchild orderable part numbers will need to change in order to meet ON Semiconductor's system requirements. Since the ON Semiconductor product management systems do not have the ability to manage part nomenclature that utilizes an underscore (\_), the underscore (\_) in the Fairchild part numbers will be changed to a dash (-). This document may contain device numbers with an underscore (\_). Please check the ON Semiconductor website to verify the updated device numbers. The most current and up-to-date ordering information can be found at [www.onsemi.com](http://www.onsemi.com). Please email any questions regarding the system integration to [Fairchild\\_questions@onsemi.com](mailto:Fairchild_questions@onsemi.com).

ON Semiconductor and the ON Semiconductor logo are trademarks of Semiconductor Components Industries, LLC dba ON Semiconductor or its subsidiaries in the United States and/or other countries. ON Semiconductor owns the rights to a number of patents, trademarks, copyrights, trade secrets, and other intellectual property. A listing of ON Semiconductor's product/patent coverage may be accessed at [www.onsemi.com/site/pdf/Patent-Marking.pdf](http://www.onsemi.com/site/pdf/Patent-Marking.pdf). ON Semiconductor reserves the right to make changes without further notice to any products herein. ON Semiconductor makes no warranty, representation or guarantee regarding the suitability of its products for any particular purpose, nor does ON Semiconductor assume any liability arising out of the application or use of any product or circuit, and specifically disclaims any and all liability, including without limitation special, consequential or incidental damages. Buyer is responsible for its products and applications using ON Semiconductor products, including compliance with all laws, regulations and safety requirements or standards, regardless of any support or applications information provided by ON Semiconductor. "Typical" parameters which may be provided in ON Semiconductor data sheets and/or specifications can and do vary in different applications and actual performance may vary over time. All operating parameters, including "Typicals" must be validated for each customer application by customer's technical experts. ON Semiconductor does not convey any license under its patent rights nor the rights of others. ON Semiconductor products are not designed, intended, or authorized for use as a critical component in life support systems or any FDA Class 3 medical devices or medical devices with a same or similar classification in a foreign jurisdiction or any devices intended for implantation in the human body. Should Buyer purchase or use ON Semiconductor products for any such unintended or unauthorized application, Buyer shall indemnify and hold ON Semiconductor and its officers, employees, subsidiaries, affiliates, and distributors harmless against all claims, costs, damages, and expenses, and reasonable attorney fees arising out of, directly or indirectly, any claim of personal injury or death associated with such unintended or unauthorized use, even if such claim alleges that ON Semiconductor was negligent regarding the design or manufacture of the part. ON Semiconductor is an Equal Opportunity/Affirmative Action Employer. This literature is subject to all applicable copyright laws and is not for resale in any manner.



# SG6859A

## Low-Cost, Green-Mode PWM Controller for Flyback Converters

### Features

- Green-Mode PWM
- Supports the “Blue Angel” Standard
- Low Startup Current: 9  $\mu$ A
- Low Operating Current: 3 mA
- 300 mA Driving Capability
- Leading-Edge Blanking
- Constant Output Power Limit
- Universal Input
- Built-in Synchronized Slope Compensation
- Current-Mode Operation
- Cycle-by-cycle Current Limiting
- Under-Voltage Lockout (UVLO)
- Programmable PWM Frequency with Frequency Hopping
- $V_{DD}$  Over-Voltage Protection (Auto Restart)
- Gate Output Voltage Clamped at 17 V
- Low Cost
- Few External Components Required
- Small SOT23-6L Package

### Applications

General-purpose switching mode power supplies and flyback power converters, such as:

- Battery chargers for cellular phones, cordless phones, PDAs, digital cameras, and power tools
- Power adapters for ink jet printers, video game consoles, and portable audio players
- Open-frame SMPS for TV/DVD standby and auxiliary supplies, home appliances, and consumer electronics
- Replacements for linear transformers and RCC SMPS
- PC 5 V standby power

### Description

This highly integrated PWM controller provides several enhancements designed to meet the low standby-power needs of low-power SMPS. To minimize standby power consumption, the proprietary green-mode function provides off-time modulation to linearly decrease the switching frequency under light-load conditions. This green-mode function enables the power supply to meet even the strictest power conservation requirements.

The BiCMOS fabrication process enables reducing the startup current to 9  $\mu$ A and the operating current to 3 mA. To further improve power conservation, a large startup resistance can be used. Built-in synchronized slope compensation ensures the stability of peak current mode control. Proprietary internal compensation provides a constant output power limit over a universal AC input range (90  $V_{AC}$  to 264  $V_{AC}$ ). Pulse-by-pulse current limiting ensures safe operation during short-circuits.

To protect the external power MOSFET from damage by supply over voltage, the SG6859A's output driver is clamped at 17 V. SG6859A controllers can be used to improve the performance and reduce the production cost of power supplies. The best choice for replacing linear and RCC-mode power adapters, the SG6859A is available in 8-pin DIP and 6-pin SOT23-6L packages.

### Ordering Information

Part Number	Operating Temperature Range	Package	Packing Method
SG6859ATZ	-40 to +105°C	SOT23-6L	Tape & Reel
SG6859ATY		SOT23-6L	
SG6859ADZ		DIP-8	Tube
SG6859ADY			

### Application Diagram

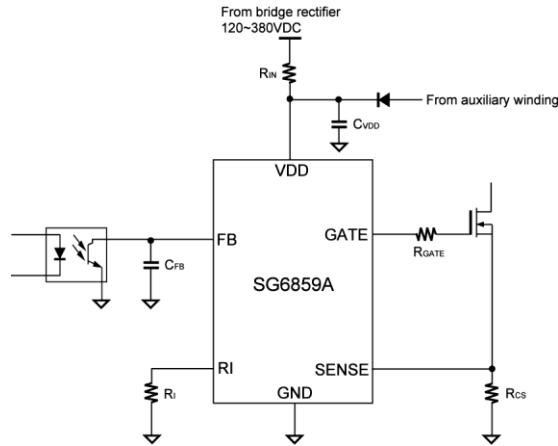


Figure 1. Typical Application

### Internal Block Diagram

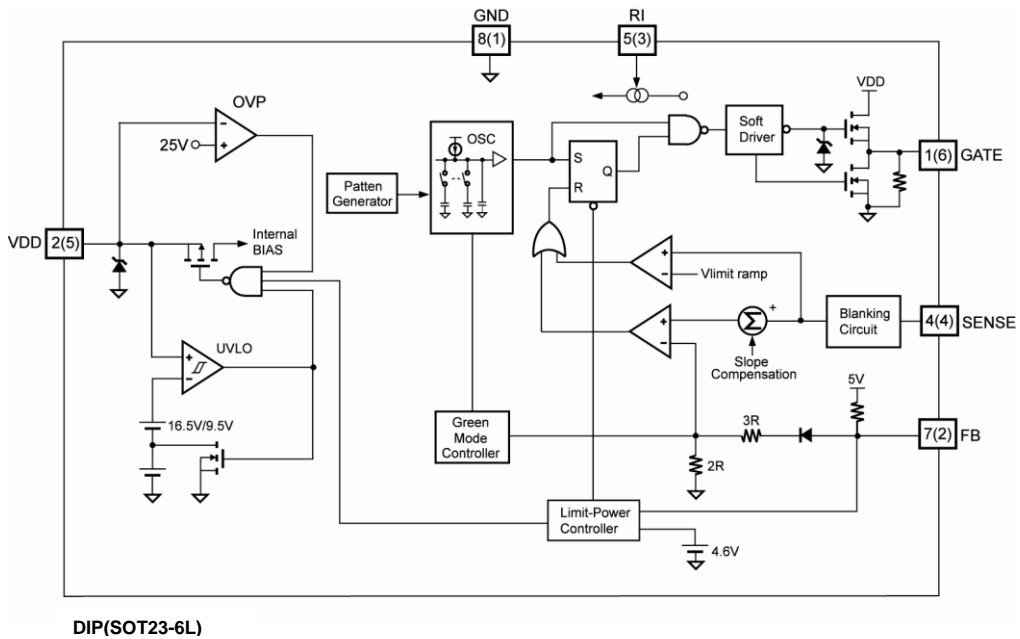
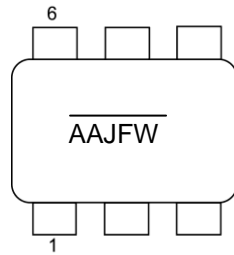


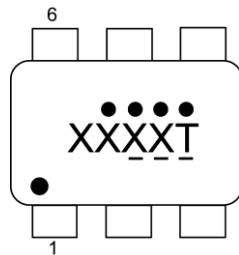
Figure 2. Functional Block Diagram

## Marking Information



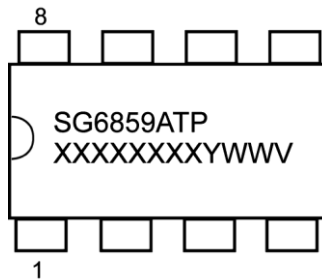
AAJF: SG6859A  
 W: Week Code  
 A~Z=W1~W26  
 A~Z=W27~W52  
 — : Lead Free Package

\*Marking for SG6859ATZ (Pb-free)



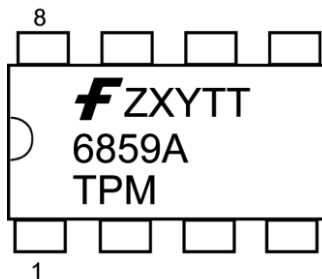
XXXX: AAJF=SG6859A  
 T : Die Run Code  
 . . . . : Year Code  
 - - - : Week Code

\*Marking for SG6859ATY (Green Compound)



T: D=DIP  
 P: Z= Lead Free + RoHS Compatible  
 Null=Regular Package  
 XXXXXXXX: Wafer Lot  
 Y: Year  
 WW: Week  
 V: Assembly Location

\*Marking for SG6859ADZ (Pb-free)



F- Fairchild Logo  
 Z- Plant Code  
 X- 1-Digit Year Code  
 Y- 1-Digit Week Code  
 TT- 2-Digit Die Run Code  
 T: Package Type (D=DIP)  
 P: Y: Green Package  
 M: Manufacture Flow Code

\*Marking for SG6859ADY (Green Compound)

Figure 3. Top Mark

## Pin Configurations

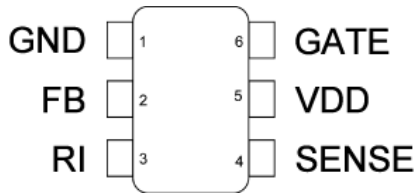


Figure 4. SOT23-6L Pin Configuration

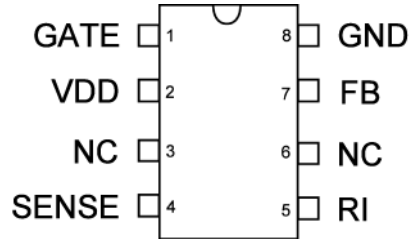


Figure 5. DIP-8 Pin Configuration

## Pin Definitions

DIP Pin #	SOT Pin #	Name	Description
1	6	GATE	The totem-pole output driver for driving the power MOSFET.
2	5	VDD	Power supply
3		NC	No connection
4	4	SENSE	Current sense. This pin senses the voltage across a resistor. When the voltage reaches the internal threshold, PWM output is disabled. This activates over-current protection. This pin also provides current amplitude information for current-mode control.
5	3	RI	A resistor connected from the RI pin to ground generates a constant current source used to charge an internal capacitor and determine the switching frequency. Increasing the resistance reduces the amplitude of the current source and the switching frequency. A 95 kΩ resistor $R_I$ results in a 50 μA constant current $I_I$ and a 70 kHz switching frequency.
6		NC	No connection
7	2	FB	Feedback. The FB pin provides the output voltage regulation signal. It provides feedback to the internal PWM comparator, so that the PWM comparator can control the duty cycle.
8	1	GND	Ground

## Absolute Maximum Ratings

Stresses exceeding the absolute maximum ratings may damage the device. The device may not function or be operable above the recommended operating conditions and stressing the parts to these levels is not recommended. In addition, extended exposure to stresses above the recommended operating conditions may affect device reliability. The absolute maximum ratings are stress ratings only.

Symbol	Parameter	Min.	Max.	Unit
V <sub>VDD</sub>	DC Supply Voltage <sup>(1, 2)</sup>		30	V
V <sub>FB</sub>	Input Voltage to FB Pin	-0.3	7.0	V
V <sub>SENSE</sub>	Input Voltage to Sense Pin	-0.3	7.0	V
T <sub>J</sub>	Operating Junction Temperature		150	°C
Θ <sub>JA</sub>	Thermal Resistance (Junction-to-Air)	SOT23-6L	273	°C/W
		DIP	113	°C/W
T <sub>STG</sub>	Storage Temperature Range	-55	+150	°C
T <sub>L</sub>	Lead Temperature (Wave Soldering or IR, 10 Seconds)		+260	°C
ESD	Electrostatic Discharge Capability, Human Body Model JESD22-A114		3.5	kV
	Electrostatic Discharge Capability, Charged Device Model JESD22-C101		1.5	kV
	Electrostatic Discharge Capability, Machine Model, JESD22-A115		200	V

### Notes:

- All voltage values, except differential voltages, are given with respect to GND pin.
- Stresses beyond those listed under Absolute Maximum Ratings may cause permanent damage to the device.

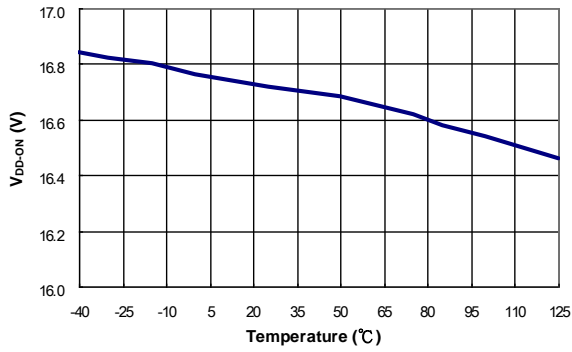
## Electrical Characteristics

Unless otherwise noted,  $V_{DD}=15\text{ V}$  and  $T_A=25^\circ\text{C}$ .

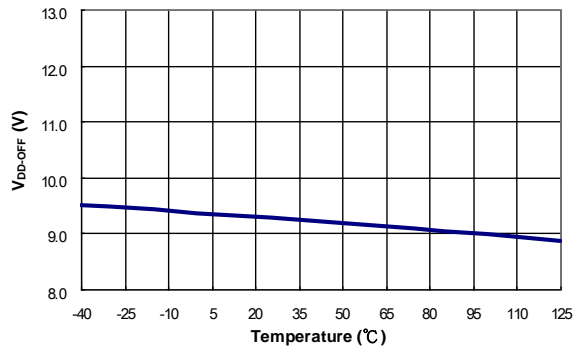
Symbol	Parameter	Conditions	Min.	Typ.	Max.	Units	
<b>V<sub>DD</sub> Section</b>							
$V_{DD-OP}$	Continuously Operation Voltage				22	V	
$V_{DD-ON}$	Turn-on Threshold Voltage		15.5	16.5	17.5	V	
$V_{DD-OFF}$	Turn-off Threshold Voltage		8.5	9.5	10.5	V	
$I_{DD-ST}$	Startup Current	$V_{DD}=V_{DD-ON} - 0.1\text{ V}$		9	15	$\mu\text{A}$	
$I_{DD-OP}$	Operating Supply Current	$V_{DD}=15\text{ V}$ , $C_L=1\text{ nF}$		3.0	3.5	mA	
$V_{DD-OVP}$	$V_{DD}$ Over-Voltage Protection Level	Auto Restart	24	25	26	V	
$t_{D-VDDOVP}$	$V_{DD}$ Over-Voltage Protection Debounce	Auto Restart		125		$\mu\text{s}$	
$V_{DD-G OFF}$	$V_{DD}$ Low-Threshold Voltage to Exit Green-off Mode			$V_{DD-OFF} + 1$		V	
<b>Feedback Input Section</b>							
$Z_{FB}$	Input Impedance			5		k $\Omega$	
$V_{FB-OPEN}$	FB Output High Voltage		5			V	
$V_{FB-OL}$	FB Open-loop Trigger Level		4.3	4.6	4.9	V	
$t_{D-OLP}$	Delay of FB Pin Open-loop Protection			56		ms	
$V_{FB-N}$	Green-Mode Entry FB Voltage		2.60	2.85	3.10	V	
$V_{FB-G}$	Green-Mode Ending FB Voltage			2.2		V	
$S_G$	Green-Mode Modulation Slope	$R_I=95\text{ k}\Omega$	40	75	100	Hz/mV	
<b>Current-Sense Section</b>							
$Z_{SENSE}$	Input Impedance		10			k $\Omega$	
$t_{PD}$	Delay to Output		40	55	100	ns	
$V_{STHFL}$	Flat Threshold Voltage for Current Limit			1		V	
$V_{STHVA}$	Valley Threshold Voltage for Current Limit		0.75	0.80	0.85	V	
$t_{LEB}$	Leading-Edge Blanking Time		270	320	370	ns	
$DCY_{SAW}$	Duty Cycle of SAW Limit			40		%	
<b>Oscillator Section</b>							
$f_{OSC}$	Frequency	Center Frequency	$R_I=95\text{ k}\Omega$	65	70	75	kHz
		Hopping Range			$\pm 4.9$		
$T_{HOP}$	Hopping Period	$R_I=95\text{ k}\Omega$		3.7		ms	
$f_{OSC-G}$	Green-Mode Frequency	$R_I=95\text{ k}\Omega$		20		kHz	
$f_{DV}$	Frequency Variation vs. $V_{DD}$ Deviation	$V_{DD}=13.5\text{ to }22\text{ V}$	0	0.02	2.00	%	
$f_{DT}$	Frequency Variation vs. Temp. Deviation	$T_A=-20\text{ to }85^\circ\text{C}$			2	%	
<b>Output Section</b>							
$DCY_{MAX}$	Maximum Duty Cycle		62	67	72	%	
$V_{GATE-L}$	Output Voltage Low	$V_{DD}=15\text{ V}$ , $I_O=20\text{ mA}$			1.4	V	
$V_{GATE-H}$	Output Voltage High	$V_{DD}=13.5\text{ V}$ , $I_O=20\text{ mA}$	8			V	
$t_r$	Rising Time	$V_{DD}=15\text{ V}$ , $C_L=1\text{ nF}$		150		ns	
$t_f$	Falling Time	$V_{DD}=15\text{ V}$ , $C_L=1\text{ nF}$		55		ns	
$V_{GATE-CLAMP}$	Output Clamp Voltage	$V_{DD}=22\text{ V}$	16	17	18	V	



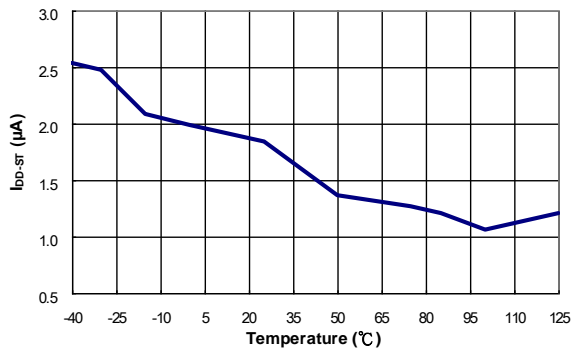
## Typical Performance Characteristics



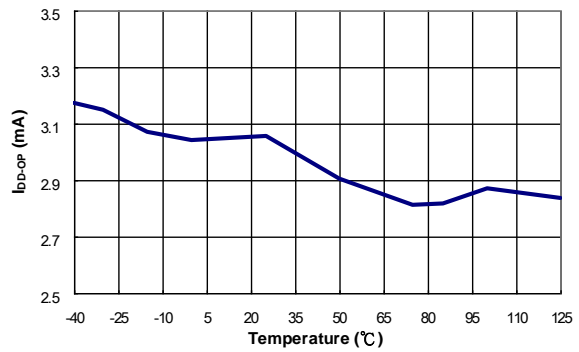
**Figure 6. Turn-on Threshold Voltage (V<sub>DD-ON</sub>) vs. Temperature**



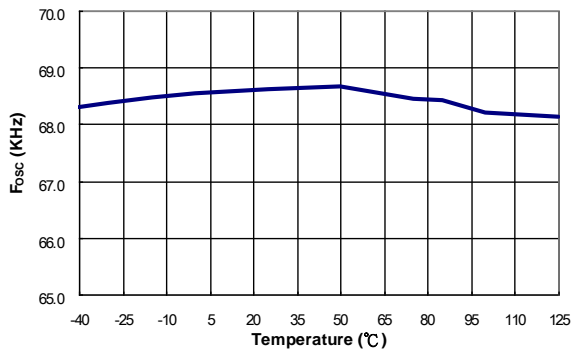
**Figure 7. Turn-off Threshold Voltage (V<sub>DD-OFF</sub>) vs. Temperature**



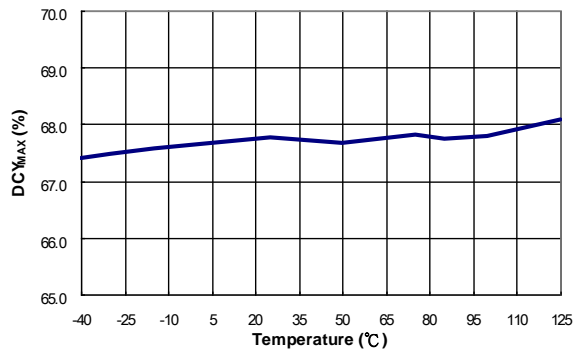
**Figure 8. Startup Current (I<sub>DD-ST</sub>) vs. Temperature**



**Figure 9. Operating Supply Current (I<sub>DD-OP</sub>) vs. Temperature**

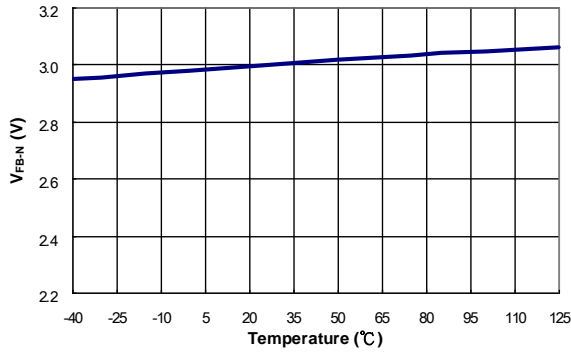


**Figure 10. Center Frequency (f<sub>OSC</sub>) vs. Temperature**

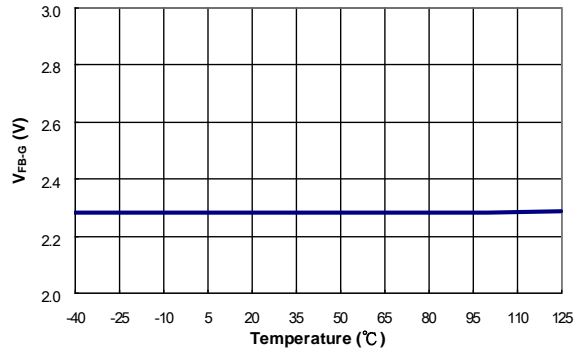


**Figure 11. Maximum Duty Cycle (DCY<sub>MAX</sub>) vs. Temperature**

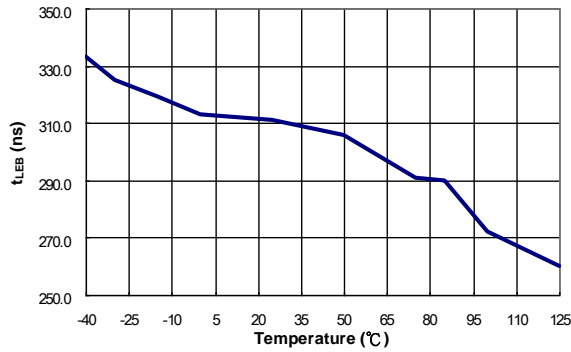
## Typical Performance Characteristics



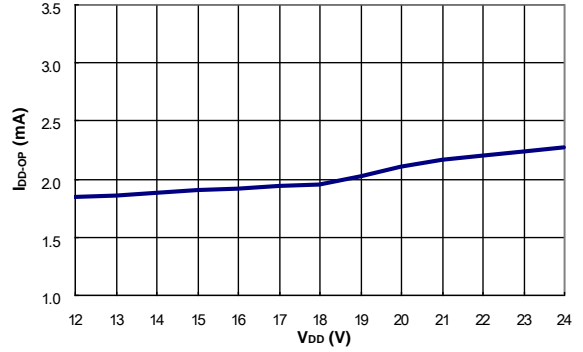
**Figure 12. Green-Mode Entry FB Voltage (V<sub>FB-N</sub>) vs. Temperature**



**Figure 13. Green-Mode Ending FB Voltage (V<sub>FB-G</sub>) vs. Temperature**



**Figure 14. Leading-Edge Blanking Time (t<sub>LEB</sub>) vs. Temperature**



**Figure 15. Operating Supply Current vs. V<sub>DD</sub> Voltage**

## Operation Description

SG6859A devices integrate many useful designs into one controller for low-power, switch-mode power supplies. The following descriptions highlight some of the features of the SG6859A series.

### Startup Current

The startup current is only 9  $\mu\text{A}$ . Low startup current allows a startup resistor with high resistance and low-wattage to supply the startup power for the controller. A 1.5 M $\Omega$ , 0.25 W, startup resistor and a 10  $\mu\text{F}/25\text{V}$   $V_{\text{DD}}$  hold-up capacitor are sufficient for an AC-to-DC power adapter with a wide input range (100  $V_{\text{AC}}$  to 240  $V_{\text{AC}}$ ).

### Operating Current

The operating current has been reduced to 3 mA. The low operating current results in higher efficiency and reduces the  $V_{\text{DD}}$  hold-up capacitance requirement.

### Green-Mode Operation

The proprietary green-mode function provides off-time modulation to linearly decrease the switching frequency under light-load conditions. On-time is limited to provide stronger protection against brownouts and other abnormal conditions. The feedback current, which is sampled from the voltage feedback loop, is taken as the reference. Once the feedback current exceeds the threshold current, the switching frequency starts to decrease. This green-mode function dramatically reduces power consumption under light-load and zero-load conditions. Power supplies using the SG6859A can meet even the strictest regulations regarding standby power consumption.

### Oscillator Operation

A resistor connected from the RI pin to ground generates a constant current source used to charge an internal capacitor. The charge time determines the internal clock speed and the switching frequency. Increasing the resistance reduces the amplitude of the input current and the switching frequency. A 95 k $\Omega$   $R_{\text{I}}$  resistor results in a 50  $\mu\text{A}$  constant current,  $I_{\text{I}}$ , and a 70 kHz switching frequency. The relationship between  $R_{\text{I}}$  and the switching frequency is:

$$f_{\text{PWM}} = \frac{6650}{R_{\text{I}}(\text{k}\Omega)} \text{ (kHz)} \quad (1)$$

The recommended  $f_{\text{PWM}}$  is from 50kHz to 80kHz.

### Leading-Edge Blanking

Each time the power MOSFET is switched on, a turn-on spike occurs at the sense-resistor. To avoid premature termination of the switching pulse, a 320 ns leading-edge blanking time is built in. Conventional RC filtering can be omitted. During this blanking period, the current-limit comparator is disabled and cannot switch off the gate driver.

### Constant Output Power Limit

When the SENSE voltage across the sense resistor,  $R_{\text{S}}$ , reaches the threshold voltage (around 1 V), the

output GATE drive is turned off following a short propagation delay,  $t_{\text{PD}}$ . This propagation delay introduces an additional current proportional to  $t_{\text{PD}} \cdot V_{\text{IN}} / L_{\text{P}}$ . The propagation delay is nearly constant, regardless of the input line voltage  $V_{\text{IN}}$ . Higher input line voltages result in larger additional currents. At high input line voltages, the output power limit is higher than at low input line voltages. To compensate for this output power limit variation across a wide AC input range, the threshold voltage is adjusted by adding a positive ramp. This ramp signal rises from 0.8 V to 1 V, then flattens out at 1 V. A smaller threshold voltage forces the output GATE drive to terminate earlier, which reduces the total PWM turn-on time and makes the output power equal to that of low line input. This proprietary internal compensation ensures a constant output power limit for a wide AC input voltage range (90  $V_{\text{AC}}$  to 264  $V_{\text{AC}}$ ).

### Under-Voltage Lockout (UVLO)

The turn-on and turn-off thresholds are fixed internally at 16.5 V and 9.5 V. During startup, the hold-up capacitor must be charged to 16.5V through the startup resistor to enable the SG6859A. The hold-up capacitor continues to supply  $V_{\text{DD}}$  until power can be delivered from the auxiliary winding of the main transformer.  $V_{\text{DD}}$  must not drop below 9.5 V during this startup process. This UVLO hysteresis window ensures that hold-up capacitor is adequate to supply  $V_{\text{DD}}$  during startup.

### Gate Output

The BiCMOS output stage is a fast totem pole gate driver. Cross conduction has been avoided to minimize heat dissipation, increase efficiency, and enhance reliability. The output driver is clamped by an internal 17 V Zener diode to protect power MOSFET transistors against undesired over-voltage gate signals.

### Built-in Slope Compensation

The sensed voltage across the current-sense resistor is used for current-mode control and pulse-by-pulse current limiting. Built-in slope compensation improves stability and prevents sub-harmonic oscillations due to peak-current mode control. The SG6859A has a synchronized, positively-sloped ramp built-in at each switching cycle. The slope of the ramp is:

$$\frac{0.36 \times \text{Duty}}{\text{Duty (max.)}} \quad (2)$$

### Noise Immunity

Noise from the current sense or the control signal can cause significant pulse-width jitter, particularly in continuous-conduction mode (CCM). While slope compensation helps alleviate these problems, further precautions should still be taken. Good placement and layout practices should be followed. Avoiding long PCB traces and component leads, locating compensation and filter components near the SG6859A, and increasing power MOS gate resistance improve performance.

## Applications Information

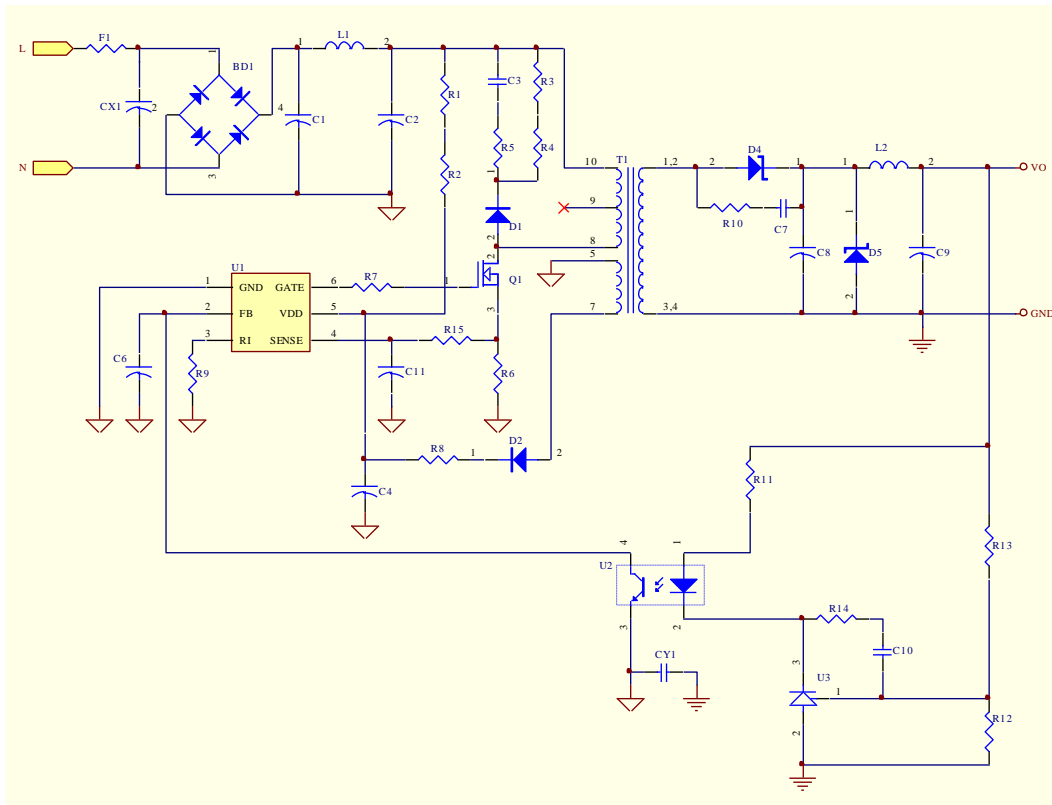
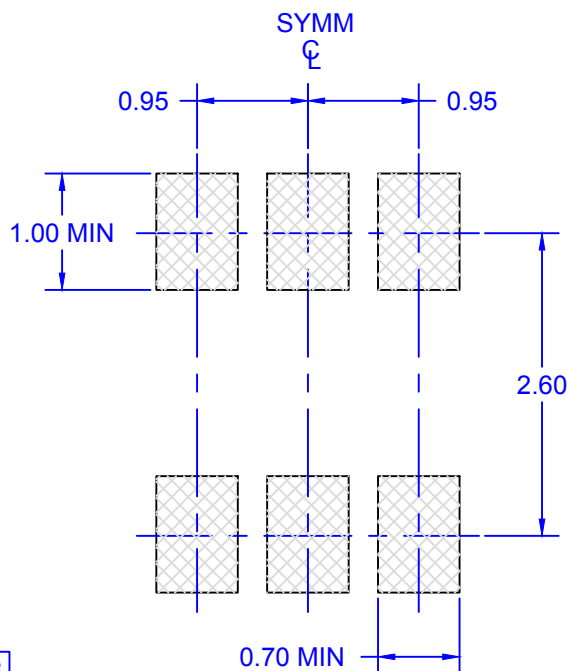
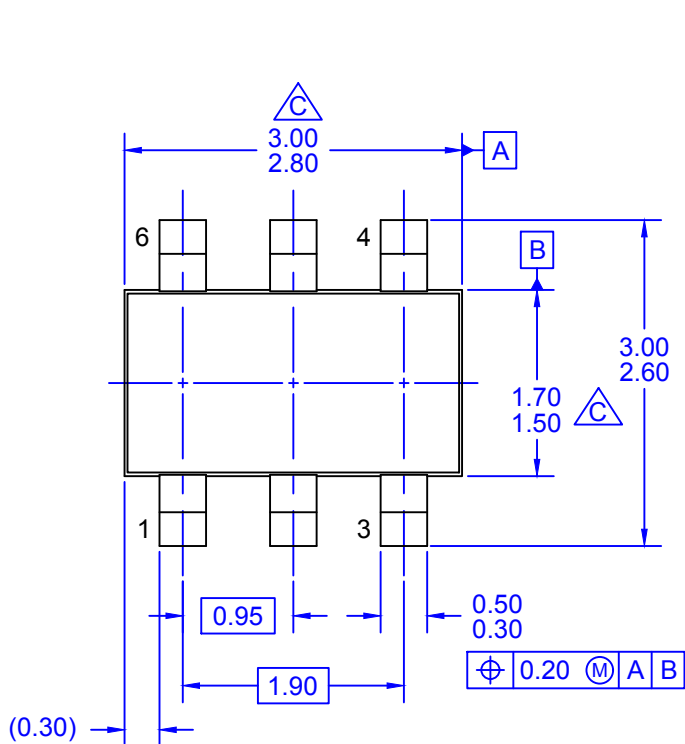


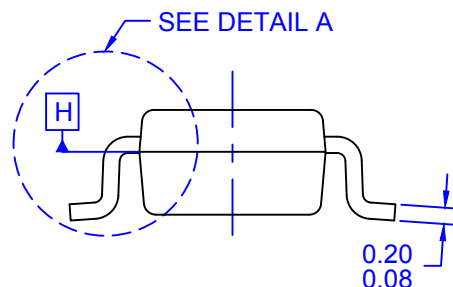
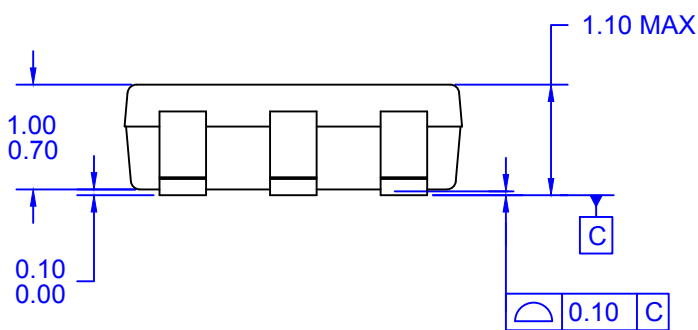
Figure 16. Reference Circuit

## Bill of Materials (BOM)

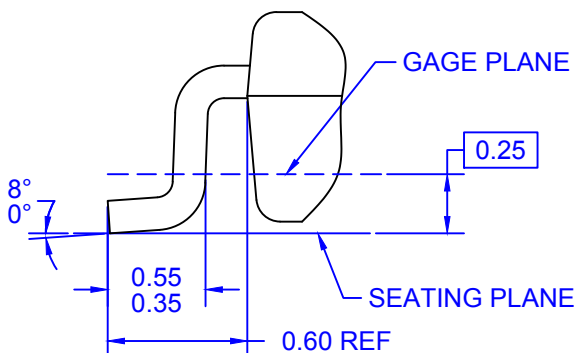
Reference	Component	Reference	Component
BD1	BD 1 A/500 V	L2	10 $\mu$ H 6 mm
CX1 (Optional)	XC 0.1 $\mu$ F	Q1	MOSFET 1 A/600 V
CY1 (Optional)	YC 1nF/400 V (Y1)	R1,R2	R 750 K $\Omega$ 1206
C1	CC 10 nF/500 V	R3,R4	R 47 K $\Omega$ 1206
C2	EC 10 $\mu$ F/400 V 105°C	R5	R 47 $\Omega$ 1206
C3	CC 1 nF/500 V	R6	R 4.7 $\Omega$ 1206
C4	EC 10 $\mu$ F/50 V	R7	R 100 $\Omega$ 0805
C6	CC 4.7 nF 0805	R8	R 10 $\Omega$ 1206
C7 (Optional)	CC 1 nF/100 V 1206	R9	R 100 K $\Omega$ 0805
C8	EC 470 $\mu$ F/10 V 105°C	R10 (Optional)	R 10 $\Omega$ 1206
C9	EC 220 $\mu$ F/10 V 105°C	R11	R 100 $\Omega$ 1/8W
C10	CC 2.2 nF 0805	R12	R 33 K $\Omega$ 0805
C11	N.C.	R13	R 33 K $\Omega$ 1/8W
D1	Diode FRI07	R14	R 4.7 K $\Omega$ 0805
D2	Diode FR102	R15	R 0 $\Omega$ 0805
D4	Diode SB360	T1	EE-16
D5 (Optional)	ZD 6.8 V 0.5 W	U1	IC SG6859A
F1	R 1 $\Omega$ /0.5 W	U2	PC817
L1	20 mH 6 $\times$ 8 mm	U3	TL431



LAND PATTERN RECOMMENDATION



- NOTES: UNLESS OTHERWISE SPECIFIED
- A) THIS PACKAGE CONFORMS TO JEDEC MO-193. VAR. AA, ISSUE E.
  - B) ALL DIMENSIONS ARE IN MILLIMETERS.
  - C) PACKAGE LENGTH DOES NOT INCLUDE MOLD FLASH, PROTRUSIONS OR GATE BURRS. MOLD FLASH, PROTRUSIONS OR GATE BURRS SHALL NOT EXCEED 0.25mm PER END. PACKAGE WIDTH DOES NOT INCLUDE INTERLEAD FLASH OR PROTRUSION. INTERLEAD FLASH OR PROTRUSION SHALL NOT EXCEED 0.25mm PER SIDE. PACKAGE LENGTH AND WIDTH DIMENSIONS ARE DETERMINED AT DATUM H.
  - D) DRAWING FILE NAME: MKT-MA06AREVF



DETAIL A  
SCALE: 50X

ON Semiconductor



ON Semiconductor and  are trademarks of Semiconductor Components Industries, LLC dba ON Semiconductor or its subsidiaries in the United States and/or other countries. ON Semiconductor owns the rights to a number of patents, trademarks, copyrights, trade secrets, and other intellectual property. A listing of ON Semiconductor's product/patent coverage may be accessed at [www.onsemi.com/site/pdf/Patent-Marking.pdf](http://www.onsemi.com/site/pdf/Patent-Marking.pdf). ON Semiconductor reserves the right to make changes without further notice to any products herein. ON Semiconductor makes no warranty, representation or guarantee regarding the suitability of its products for any particular purpose, nor does ON Semiconductor assume any liability arising out of the application or use of any product or circuit, and specifically disclaims any and all liability, including without limitation special, consequential or incidental damages. Buyer is responsible for its products and applications using ON Semiconductor products, including compliance with all laws, regulations and safety requirements or standards, regardless of any support or applications information provided by ON Semiconductor. "Typical" parameters which may be provided in ON Semiconductor data sheets and/or specifications can and do vary in different applications and actual performance may vary over time. All operating parameters, including "Typicals" must be validated for each customer application by customer's technical experts. ON Semiconductor does not convey any license under its patent rights nor the rights of others. ON Semiconductor products are not designed, intended, or authorized for use as a critical component in life support systems or any FDA Class 3 medical devices or medical devices with a same or similar classification in a foreign jurisdiction or any devices intended for implantation in the human body. Should Buyer purchase or use ON Semiconductor products for any such unintended or unauthorized application, Buyer shall indemnify and hold ON Semiconductor and its officers, employees, subsidiaries, affiliates, and distributors harmless against all claims, costs, damages, and expenses, and reasonable attorney fees arising out of, directly or indirectly, any claim of personal injury or death associated with such unintended or unauthorized use, even if such claim alleges that ON Semiconductor was negligent regarding the design or manufacture of the part. ON Semiconductor is an Equal Opportunity/Affirmative Action Employer. This literature is subject to all applicable copyright laws and is not for resale in any manner.

## PUBLICATION ORDERING INFORMATION

### LITERATURE FULFILLMENT:

Email Requests to: [orderlit@onsemi.com](mailto:orderlit@onsemi.com)

ON Semiconductor Website: [www.onsemi.com](http://www.onsemi.com)

### TECHNICAL SUPPORT

North American Technical Support:  
Voice Mail: 1 800-282-9855 Toll Free USA/Canada  
Phone: 011 421 33 790 2910

Europe, Middle East and Africa Technical Support:

Phone: 00421 33 790 2910

For additional information, please contact your local Sales Representative

# Mouser Electronics

Authorized Distributor

Click to View Pricing, Inventory, Delivery & Lifecycle Information:

[onsemi:](#)

[SG6859ATY](#) [SG6859ATZ](#) [SG6859ADZ](#)